

4

3

2

1

REVISION HISTORY

REV	DESCRIPTION	DATE	APPROVED
1	RIB SPACING	9/30/2010	JMC
2	DRAWING REVISION	3/4/2014	MPS

PARTS LIST

ITEM	QTY	PART NUMBER	DESCRIPTION
1	1	C-COLLAR-30IN	30"D COLLAR
2	1	C-LID-30IN-STD	30"D STANDARD LID
3	20	C-RIB	STRUCTURAL RIB
4	1	C-SEAM-10FT	SEAM
5	2	LIFT LUG-PLATE	LIFT LUG
6	1	CONNECTION-4IN-STUB PIPE	4"D STUB PIPE-INLET

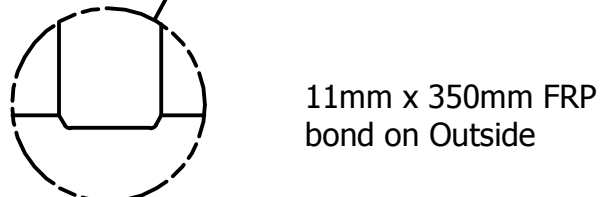
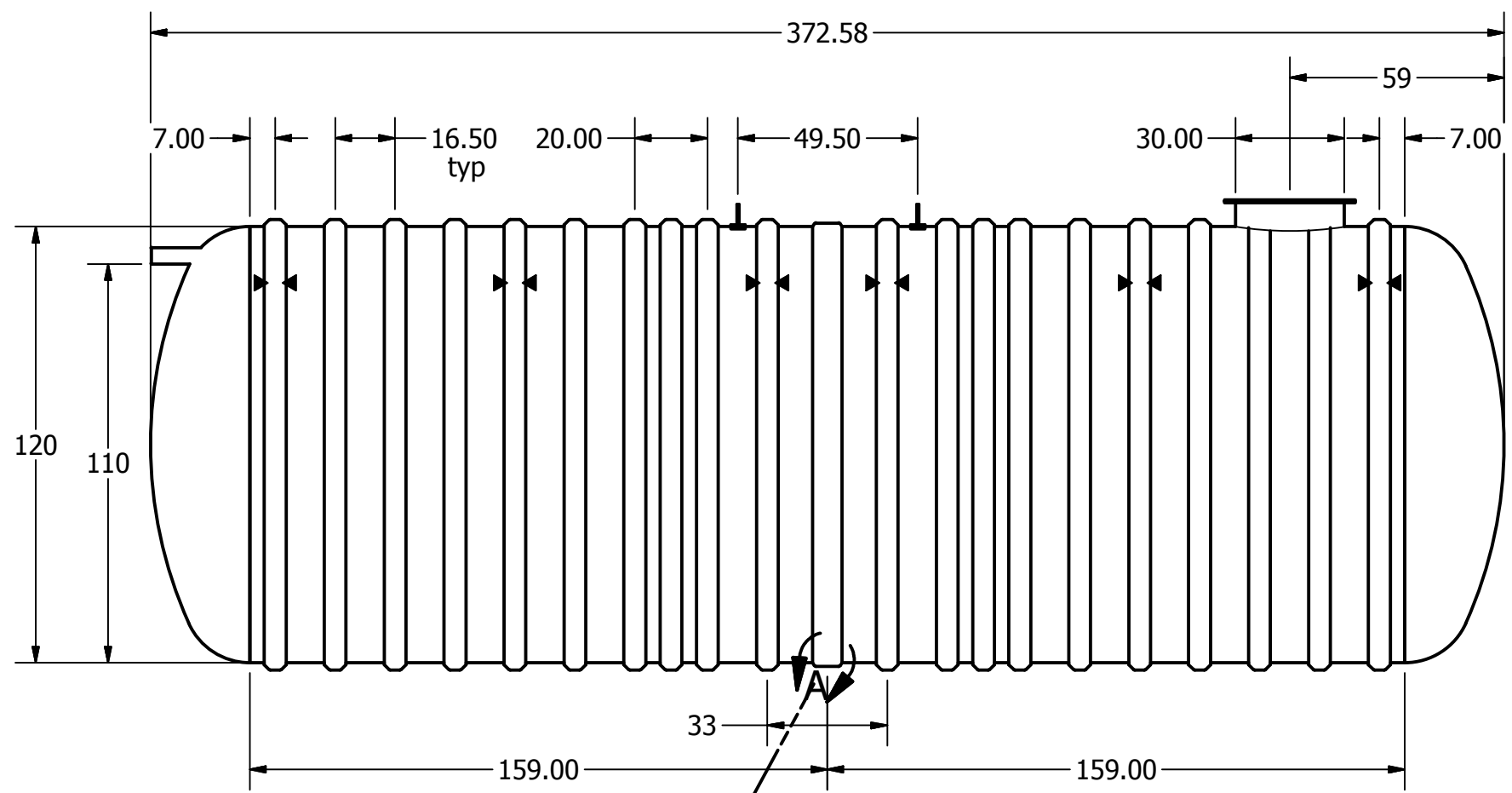
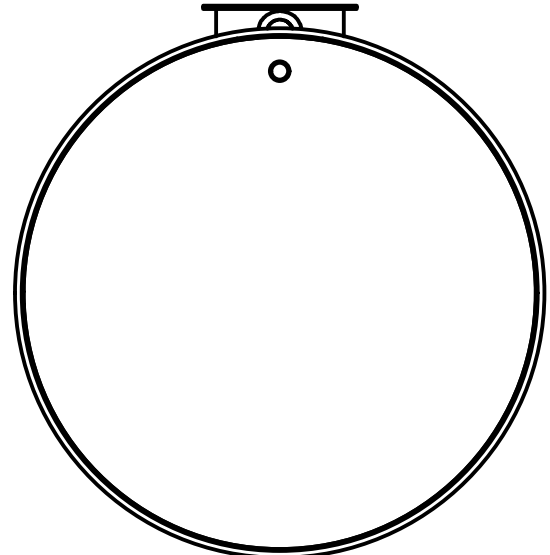
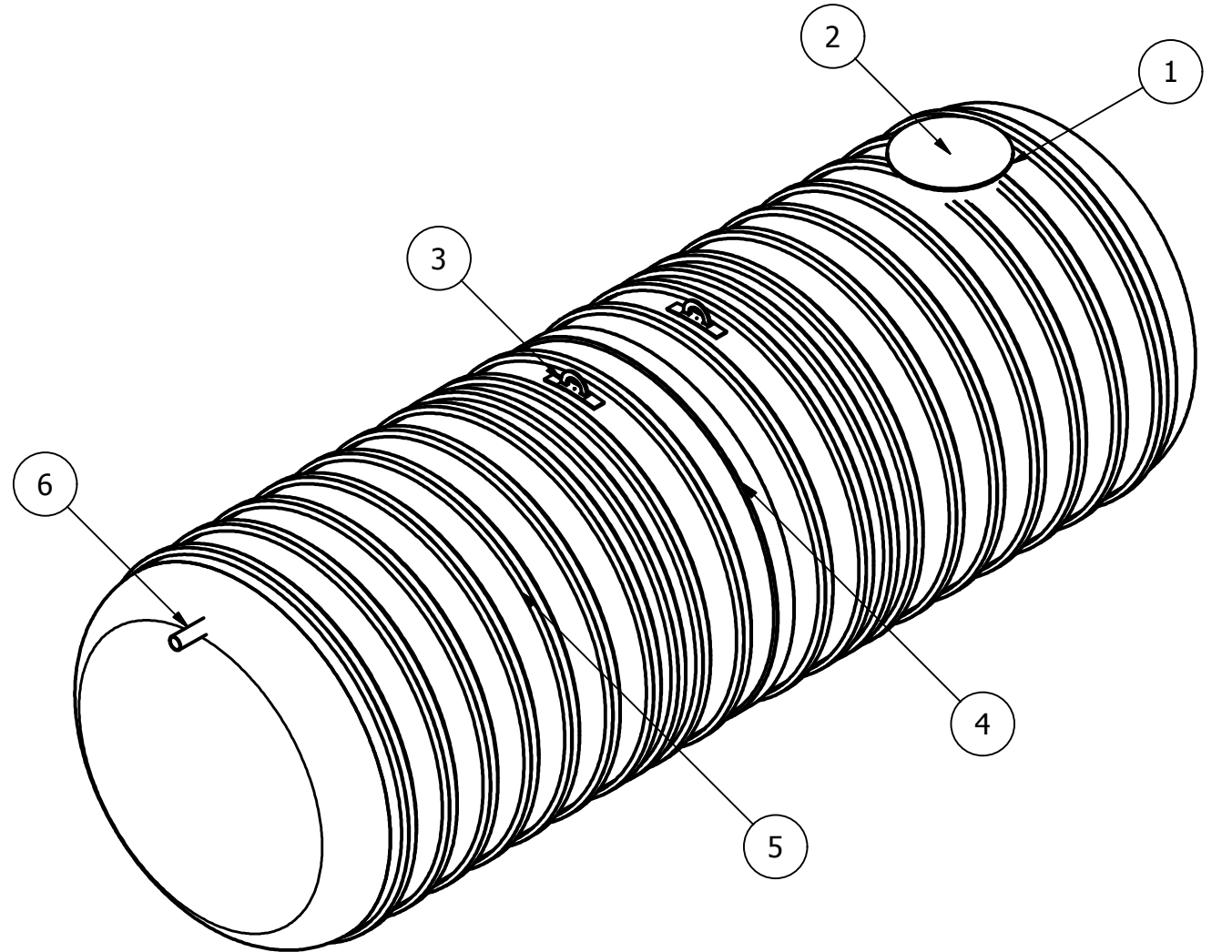
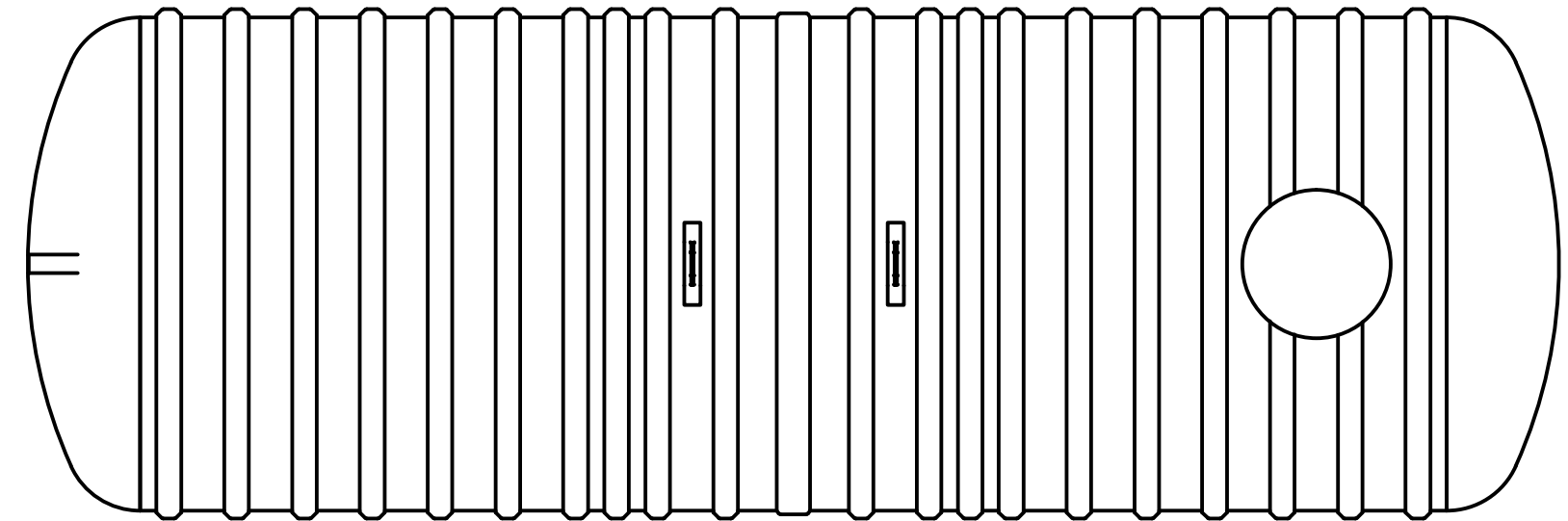



SECTIONAL JOINT DETAIL A
SCALE 1/15

Anchor Location

Item	(")	C	Item	(")
Cylinder Thickness	0.425"		Liquid Depth (holding tank)	110"
End Cap Thickness	1.03"		Septic Chamber Depth	N/A
Inlet Height (C.L.)	112"		Effluent Chamber Depth	N/A
Outlet Height (C.L.)	N/A		Chamber Wall Dimensions	N/A
Inlet Diameter	4"		Height:	N/A
Outlet Diameter	N/A		Thickness:	N/A
Rib Dimension (C to C)	16.5"		Opening Diameter:	N/A

DRAWN MPS	3/11/2014
CHECKED	
MFG	
APPROVED	
WEIGHT 2,880 kg (6,350 lbs)	LENGTH 31' 1"
WORKING CAPACITY 62,910L (13,838 IG, 16,606 USG)	
OVERALL CAPACITY 65,410L (14,388 IG, 17,266 USG)	

TITLE
BX14000S DEEP BURY UNDERGROUND FIBREGLASS SEWAGE HOLDING TANK

SIZE C	DWG NO BX14000S-DB-02	REV 2
SCALE 10' Burial Depth	SHEET 1 OF 2	