

4

3

2

1

REVISION HISTORY

REV	DESCRIPTION	DATE	APPROVED
1	RIB SPACING	9/30/2010	JMC
2	DRAWING REVISION	3/3/2014	MPS

PARTS LIST

ITEM	QTY	PART NUMBER	DESCRIPTION
1	1	C-COLLAR-30IN	30"D COLLAR
2	1	C-LID-30IN-STD	30"D STANDARD LID
3	18	C-RIB	STRUCTURAL RIB
4	1	C-SEAM-10FT	SEAM
5	2	LIFT LUG-PLATE	LIFT LUG
6	1	CONNECTION-4IN-STUB PIPE	4"D STUB PIPE-INLET

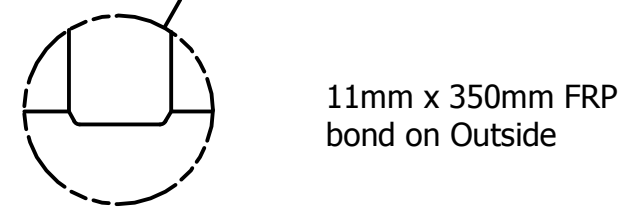
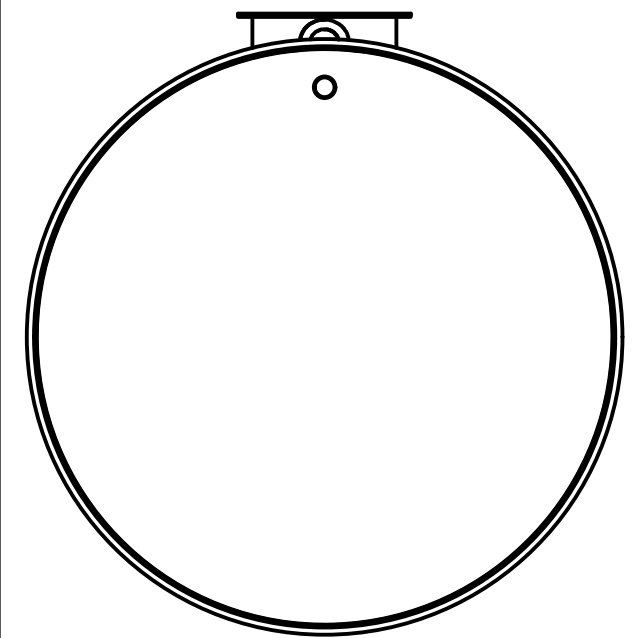
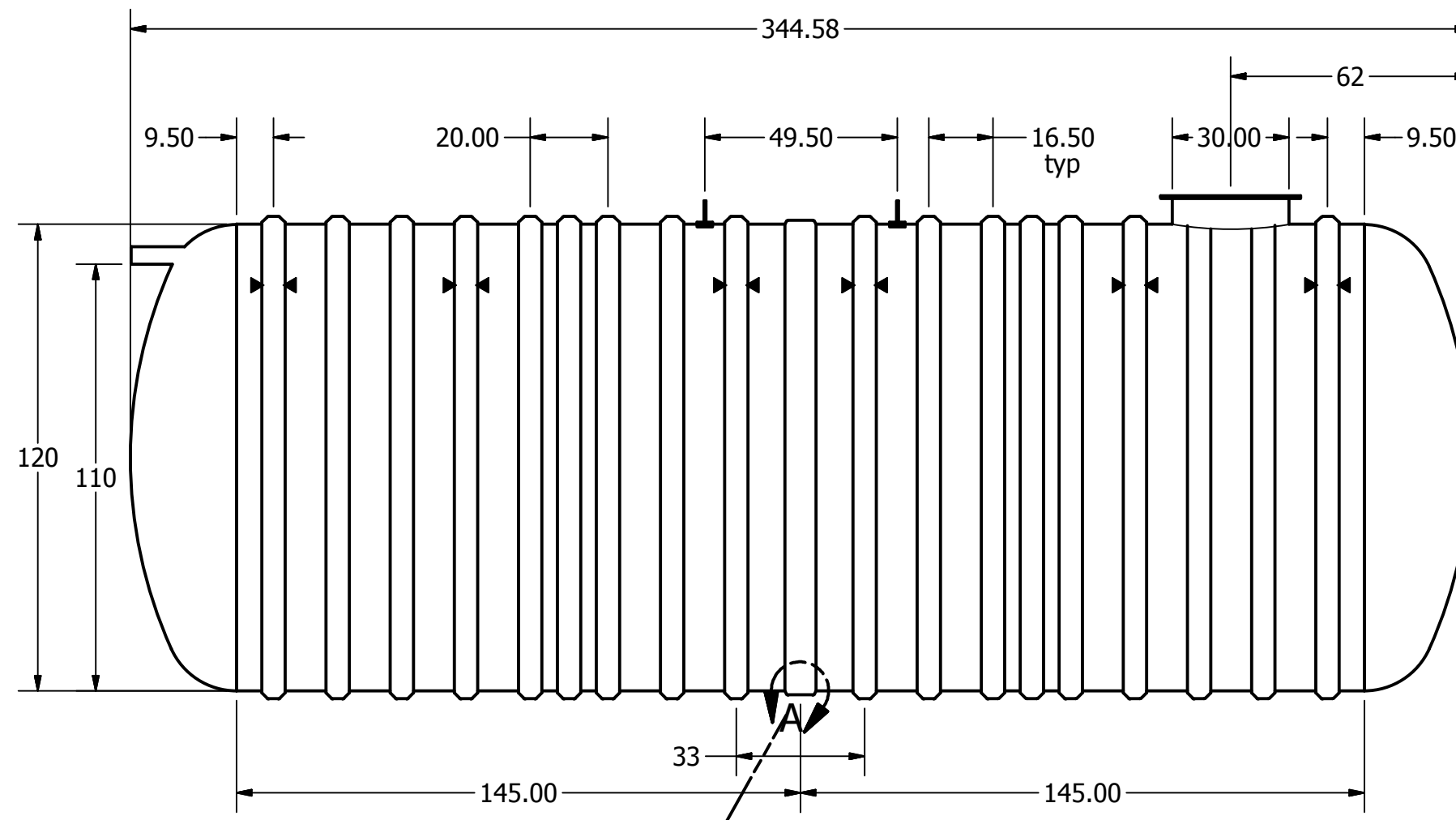
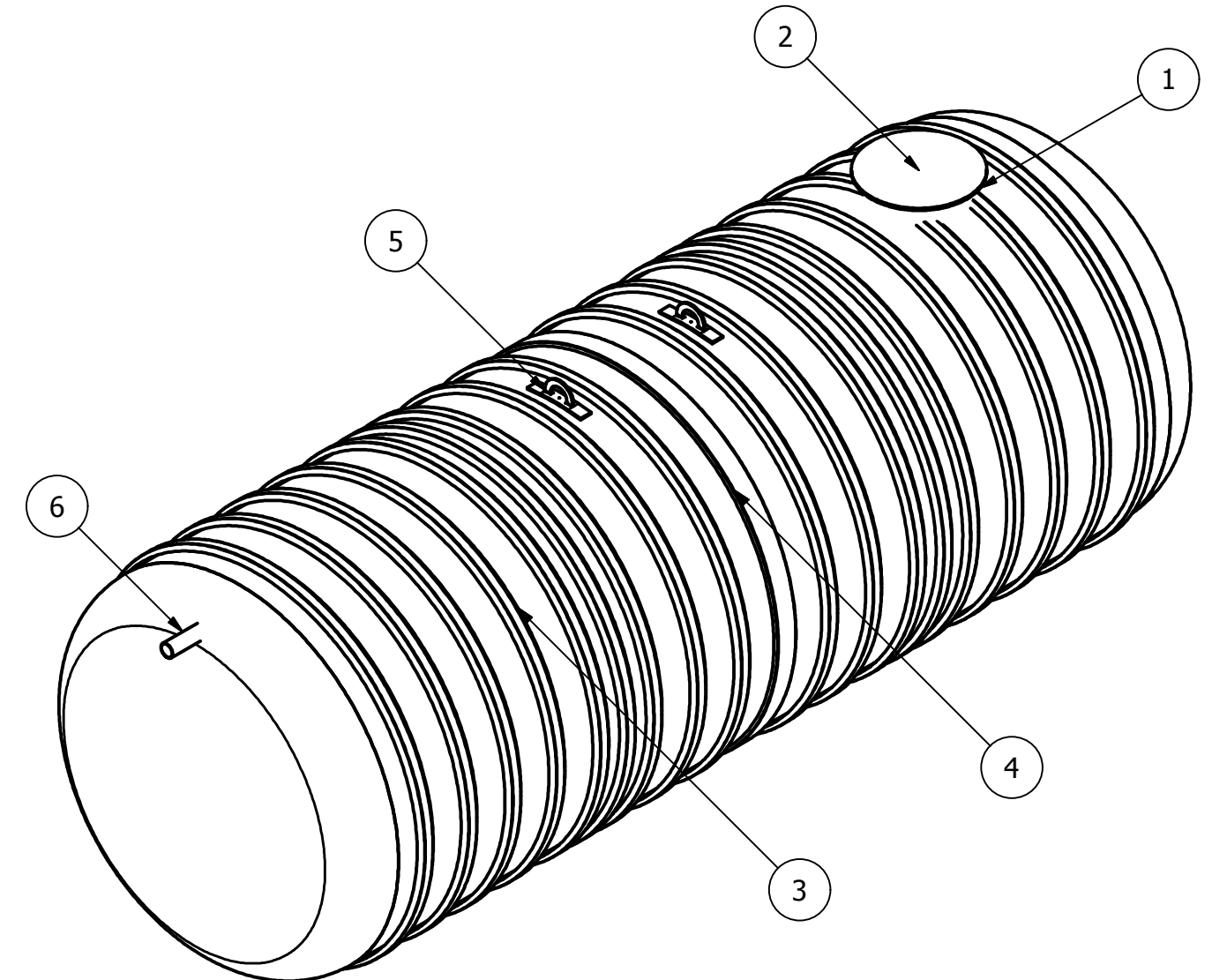
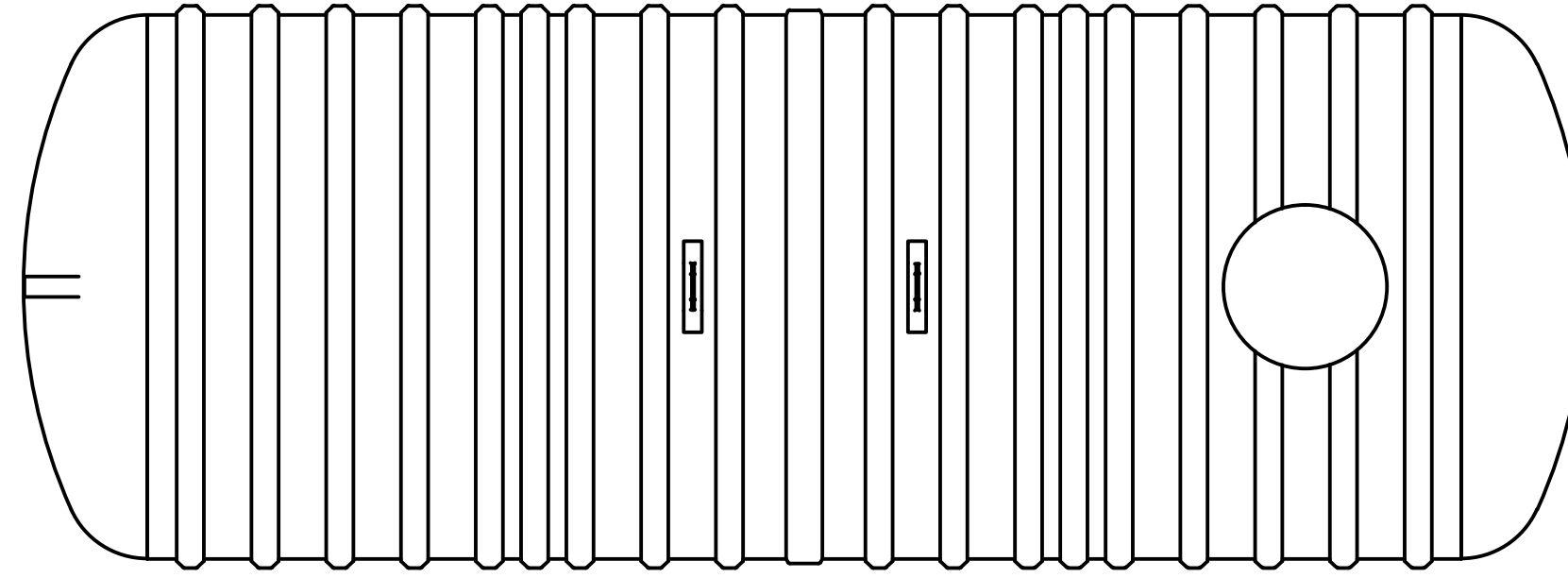

SECTIONAL JOINT DETAIL A
SCALE 1/15

Anchor Location

Item	(")	C	Item	(")
Cylinder Thickness	0.425"		Liquid Depth (holding tank)	110"
End Cap Thickness	1.03"		Septic Chamber Depth	N/A
Inlet Height (C.L.)	112"		Effluent Chamber Depth	N/A
Outlet Height (C.L.)	N/A		Chamber Wall Dimensions	N/A
Inlet Diameter	4"		Height:	N/A
Outlet Diameter	N/A		Thickness:	N/A
Rib Dimension (C to C)	16.5"		Opening Diameter:	N/A

DRAWN MPS	3/3/2014	TITLE BX13000S DEEP BURY UNDERGROUND FIBREGLASS SEWAGE HOLDING TANK	
CHECKED			
MFG			
APPROVED		SIZE C	DWG NO BX13000S-DB-02
WEIGHT 2,699 kg (5,950 lbs)	LENGTH 28' 9"	SCALE 10' Burial Depth	REV 2
WORKING CAPACITY 57,980L (12,754 IG, 15,305 USG)		SHEET 1 OF 2	
OVERALL CAPACITY 60,221L (13,247 IG, 15,896 USG)			