

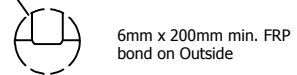

Parts List			
ITEM	QTY	PART NUMBER	DESCRIPTION
1	1	C-COLLAR-30IN	30"D COLLAR
2	1	C-LID-30IN-STD	30"D STANDARD LID
3	4	LIFT-LUG-8-10	LIFT LUG
4	4	C-RIB-GUIDE	STURUCTURAL RIB WITH ANCHOR GUIDE
5	11	C-RIB	STRUCTURAL RIB
6	1	C-SEAM-10FT	SEAM

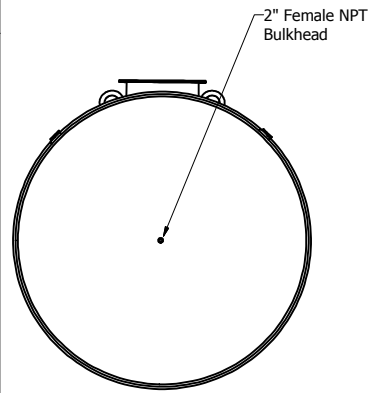
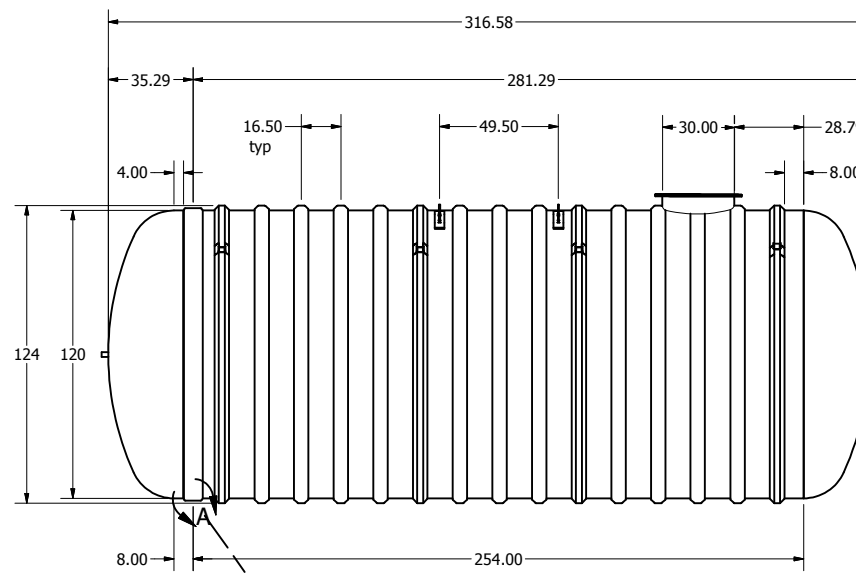
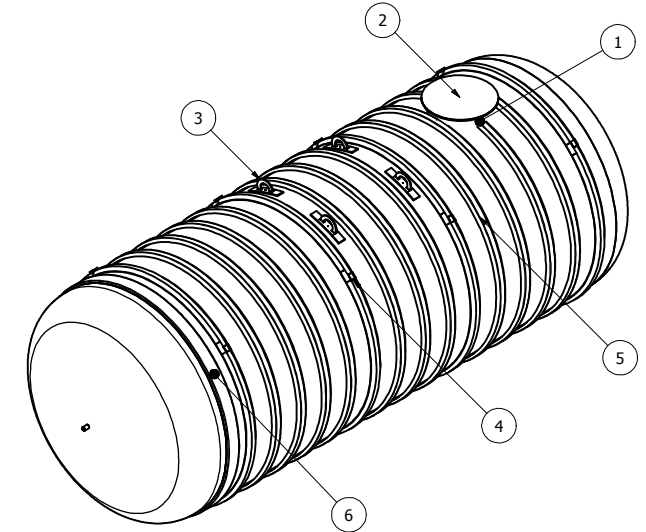
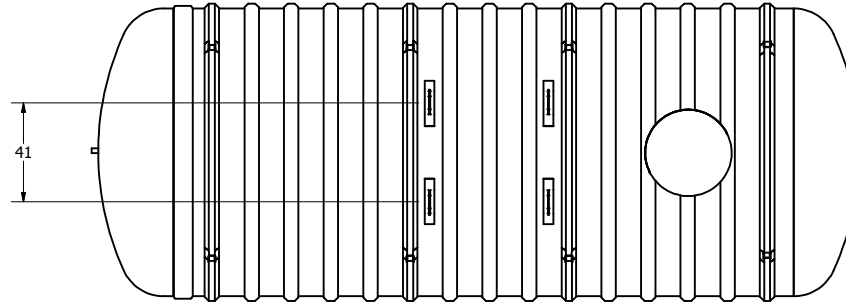

SECTIONAL JOINT DETAIL A
SCALE 1/25

OPTIONAL	PARTS
30"X12" EXTENSION	ANCHORS
30"X30" EXTENSION	FOAM INSULATION
30"X60" EXTENSION	LOCK BAR
30"X84" EXTENSION	OPTIONAL FITTING(S)
ALARM	PUMP STAND

DRAWN	MPS	3/5/2008
CHECKED		
QA		
MFG		
DCL		
APPROVED		
DCL		
WEIGHT	1,705 kg (3,750 lbs)	LENGTH 26' 5"
OVERALL CAPACITY	54,552L (12,000 IG, 14,400 USG)	

TITLE		BX12000W UNDERGROUND FIBREGLASS WATER CISTERN	
 Drinking Water <small>NSF/ANSI 61</small>			
SIZE	C	DWG NO	BX12000W-00
SCALE		REV	
SHEET 1 OF 1			